

CLP0212 Open Frame Power Supply

90 - 264Vac input; 12Vdc output; 200W Output Power



Applications

- Telecommunications equipment
- Embedded Computing
- Storage Systems
- Industrial equipment

Description

In a small 2 x 4 inch footprint, the 12Vdc single-output CLP0212 open frame power supply delivers 80 PLUS Gold energy efficiency. With its small size, the CLP series is specifically designed to handle power challenges associated with tight space and low airflow. Offering a leading 18W/in³ power density in a 1U high, fan-less form factor, the CLP series addresses a broad range of applications in new products from communications, computing and data storage original equipment manufacturers (OEMs). It delivers greater than 90 percent typical power efficiency and full load output at +50°C (122°F) with higher temperature operation possible at derated output. The CLP series utilizes a unique design approach at this power level, leveraging zero voltage switching techniques in conjunction with quasi-resonant power factor correction (PFC) circuits. Protection features include overcurrent (OCP), overvoltage (OVP), and overtemperature (OTP).

Features

- Compact size 50.8 mm x 101.6 mm x 36.1 mm (2 in x 4 in x 1.4 in) with density of 18W/in³
- Universal AC Input Range (90 - 264VAC)
- Output voltage of 12V (adjustable ±5%)
- Maximum output current of 16.7A@ 12Vout (200W)
- Standby output of 5V or 3.3V @ 0.25A
- High efficiency with 80 PLUS® Gold Certification
- Full load capability at 50°C and 1m/s (200LFM) airflow with derating at higher temperatures or lower airflows
- Remote ON/OFF
- Output overcurrent protection (non-latching)
- Overtemperature protection
- Output overvoltage protection
- Up to 12ms of holdup time
- Parallellable with current sharing
- Active power factor corrected input
- Conducted EMI - meets CISPR22 (EN55022) and FCC Class A requirements
- Compliant to RoHS EU Directive 2002/95/EC
- UL and cUL approved to UL/CSA60950-1, TUV (EN60950-1), CE Mark (for LVD) and CB Report available
- ISO** 9001 and ISO 14001 certified manufacturing facilities

* UL is a registered trademark of Underwriters Laboratories, Inc.

† CSA is a registered trademark of Canadian Standards Association.

‡ VDE is a trademark of Verband Deutscher Elektrotechniker e.V.

** ISO is a registered trademark of the International Organization of Standards

CLP0212 Open Frame Power Supply

90 - 264Vac input; 12Vdc output; 200W Output Power

Absolute Maximum Ratings

Stresses in excess of the absolute maximum ratings can cause permanent damage to the device. These are absolute stress ratings only, functional operation of the device is not implied at these or any other conditions in excess of those given in the operations sections of the data sheet. Exposure to absolute maximum ratings for extended periods can adversely affect the device reliability.

Parameter	Device	Min	Max	Unit
Input Voltage - Continuous	All	90	264	Vac
For up to 10 seconds max.	All	90	275	Vac
Operating Ambient Temperature (see Thermal Considerations section)	All	-25	70	°C
	CLP0212FPEX5Z01A, C	-40‡	85*	°C
	CLP0212FPEX5Z02A	-40‡	85*	°C
	CLP0212FPEX5Z03A, C	-40‡	85*	°C
(in sealed enclosure applications with thermally conductive pad to enclosure, $P_{O,max} = 65W$)	CLP0212FPEX5Z02A	-40	55†	°C
(in sealed enclosure applications with thermally conductive pad to enclosure, $P_{O,max} = 110W$)	CLP0212FPEX5Z03A, C	-40	55†	°C
Storage Temperature	All	-40	85	°C
Humidity (non-condensing)	All	5	95	%
Altitude	All		5000	m

‡ Startup at -40°C is limited to 80% of maximum load (160W) for all versions, except the CLP0212FPEX5Z02A which can start up at full load.

* Unit is capable of operation up to 85°C ambient for brief periods of time provided humidity is kept below 40%. Sustained operation at 85°C when input voltage is above 230VAC and output power loading is at or near the maximum rated value can degrade reliability of the product.

† Ambient temperature outside the sealed enclosure containing the power supply.

Electrical Specifications

Parameter	Device	Min	Typ	Max	Unit
Operating Input Voltage	All	90	115/230	264	Vac
Input Source Frequency	All	47	50/60	63	Hz
Input Current ($V_{IN} = 90Vac$)	All versions except CLP0212FPEX5Z02A CLP0212FPEX5Z02A			4 1.6	A_{RMS} A_{RMS}
Input Power Factor	All		0.95		
Inrush Transient Current ($V_{IN} = 264Vac$, $T_{amb} = 25°C$)	All			100	A Peak
Leakage Current to earth ground ($V_{IN} = 264Vac$)	All			2	mA
Output Voltage Setpoint	All		12		Vdc
Output Voltage Tolerance (due to set point, temperature variations, load and line regulation)	All	-2		2	%
Output Voltage Adjustment Range	All	11.4		12.6	Vdc
Output Remote Sense Range	All			250	mVdc
Output Load Regulation	All			1.5	%Vout
Output Line Regulation	All			0.5	%Vout
Output Ripple and Noise - measured with 0.1µF ceramic capacitor in parallel with 10µF tantalum capacitor, at 25°C ¹ Peak-to-peak (20MHz Bandwidth)	All			180	mV p-p
Dynamic Load Response - 50% to 75% load transient, 0.1A/µs slew rate					
Output voltage deviation	All			5%	%
Settling Time	All			500	µs
Output Current	All versions except CLP0212FPEX5Z02A	0		16.7	Adc
Output Current	CLP0212FPEX5Z02A	0		8.34	Adc
Output Current Limit Inception	All		115		% $I_{O,max}$

¹ Output ripple is 300mV p-p maximum at -40°C. To reduce further, additional external capacitance needed.

CLP0212 Open Frame Power Supply

90 - 264Vac input; 12Vdc output; 200W Output Power

Electrical Specifications (cont.)

Parameter	Device	Min	Typ	Max	Unit
Maximum Output Capacitance	All			5000	μF
Standby Output Voltage	CLP0212FPXX5Z01A CLP0212FPEX5Z01A, C		5		Vdc
	CLP0212FPXX3Z01A		3.3		Vdc
Standby Output Current	All			0.25	Adc
Efficiency: $V_{IN} = 230V_{ac}$, 20% load	All except ..Z02A		86.8		%
50% load	All except ..Z02A		91.1		%
100% load	All except ..Z02A		89.5		%
$V_{IN} = 115V_{ac}$, 20% load	All except ..Z02A		89.2		%
50% load	All except ..Z02A		90.3		%
100% load	All except ..Z02A		87.1		%
Holdup Time - $V_{IN} = 115V_{ac}$, 100% load ² 65W load for CLP0212FPEX5Z02A	All except ..Z02A CLP0212FPEX5Z02A		10 32		ms
$V_{IN} = 230V_{ac}$, 100% load 65W load for CLP0212FPEX5Z02A	All except ..Z02A CLP0212FPEX5Z02A		10 32		ms

Isolation Specifications

Parameter	Device	Min	Max	Unit
Isolation Voltage - Input to output	All		3000	Vac
Input to safety ground	All		1500	Vac
Outputs to safety ground	All		50	Vac

General Specifications

Parameter	Device	Symbol	Typ.	Unit
Calculated Reliability based on Telcordia SR-332 Issue 2: Method 1 Case 3 ($V_{IN}=230V_{ac}$, $I_o = 16.7A$, $T_A = 40^{\circ}C$, airflow 200LFM, 90% confidence)	All	FIT	1,011.9	10 ⁹ /Hours
		MTBF	988,276	Hours
Weight	All		185 6.5	g oz.

Feature Specifications

Parameter	Device	Min	Typ	Max	Unit
On/Off Signal Interface - signal referenced to GND					
Logic Low (Power Supply ON)					
Input Low Current	All			7	mA
Input Low Voltage	All			1	V
Logic High (Power Supply OFF)					
Input High Current	All			600	μA
Input Voltage	All			5.5	V
Delay from ON/OFF being enabled to start of output voltage rise	All			50	ms
Output Voltage Rise Time (from 10 to 90% of final value)	All		5		ms
Delay from Input being applied to standby output being in regulation	All		12		ms
Delay from Input being applied to all outputs being in regulation	All		30		ms
Output Overvoltage Protection (for main output currents above 0.1A)	All	13.8		18	Vdc

² Holdup time is reduced at cold temperatures

CLP0212 Open Frame Power Supply
 90 - 264Vac input; 12Vdc output; 200W Output Power

Feature Specifications (cont.)

Parameter	Device	Min	Typ	Max	Unit
Input Undervoltage lockout ³					
Turn-on Threshold (100% load)	All		86		Vac
Turn-off Threshold (100% load)	All		82		Vac
DC OK – open collector, High when output available					
Sink Current	All			4	mA
Maximum Collector Voltage	All			12	V

Environmental Specifications

Parameter	Device	Specification
Conducted Emissions	All	CISPR22 (EN55022) Class A with 3dB margin
Input Harmonics	All	EN61000-3-2
ESD	All	IEC 61000-4-2, Level 3
Radiated Immunity	All	IEC 61000-4-3, Level 2*
Electrical Fast Transient Common Mode	All	IEC 61000-4-4, Level 3
Surge Immunity	All	IEC 61000-4-5, Level 3
Conducted RF Immunity	All	IEC 61000-4-6, Level 3
Voltage Dips	All	EN61000 4.11, Level 3, Class B, C
Shock and Vibration		
Operating Shock	All	Three shocks, 15G peak, 11ms sine wave, two axes
Non-Operating Shock	All	Three shocks, 50G peak, 11ms sine wave, two axes
Operating and Non-Operating Vibration	All	5 – 9Hz, 0.5" double amplitude, 2G Peak, 0.5 oct./min., 2 cycles 9-500Hz, 4G pk-pk, 0.5 oct/min., 2 cycles

* Radiated immunity is met when the power supply is tested in a suitable enclosure.

³ The undervoltage lockout thresholds vary with output load current level – decreasing as the load goes down

CLP0212 Open Frame Power Supply

90 - 264Vac input; 12Vdc output; 200W Output Power

Characteristic Curves

The following figures provide typical characteristics for CLP0212 power supply

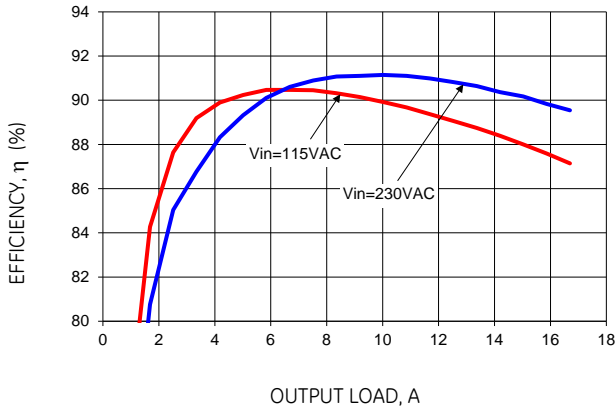

Figure 1. Power Supply Efficiency versus Output Current.

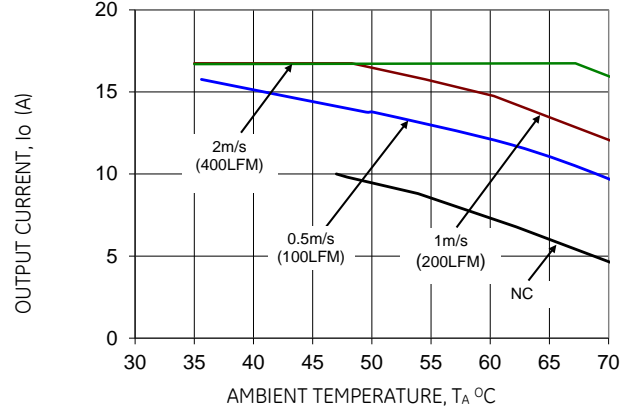

Figure 2. Derating Output Current versus Ambient Temperature and Airflow. Data shown for 115VAC in, at 230VAC in derating is the same or better. For derating at other input voltages, consult the GE Technical representative.

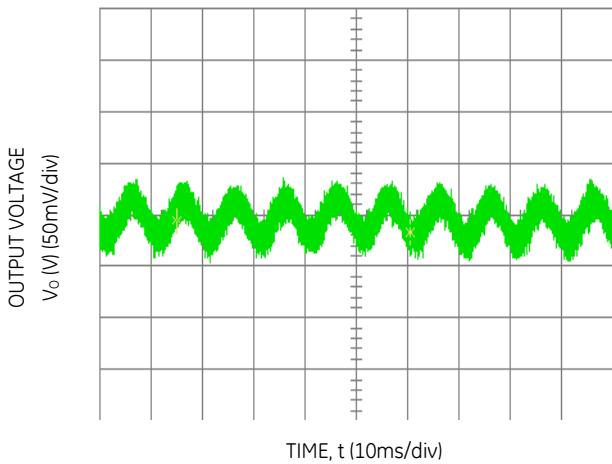

Figure 3. Typical output ripple and noise (VIN = 230Vac, 100% load).

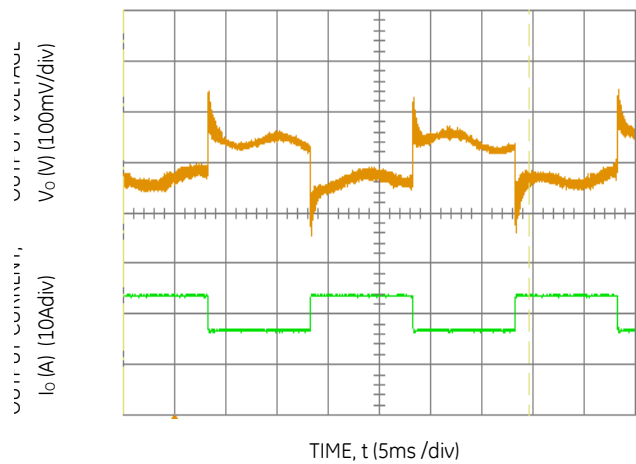

Figure 4. Transient Response to Dynamic Load Change from 50% to 100% at VIN = 230Vac.

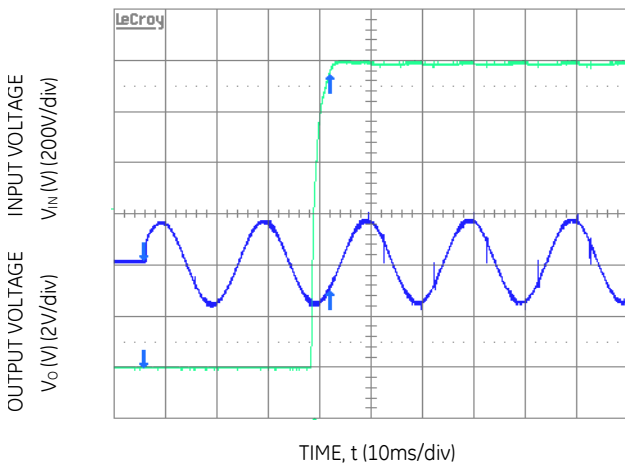

Figure 5. Typical Start-up (VIN = 115Vac).

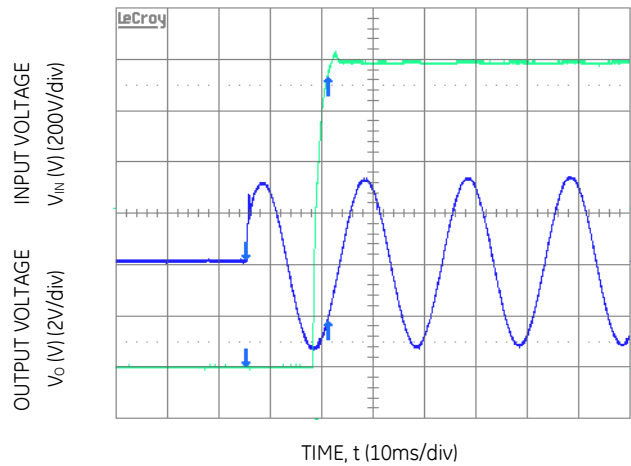

Figure 6. Typical Start-up (VIN = 230Vac)

CLP0212 Open Frame Power Supply
 90 - 264Vac input; 12Vdc output; 200W Output Power

Characteristic Curves (cont.)

The following figures provide typical characteristics for CLP0212 power supply

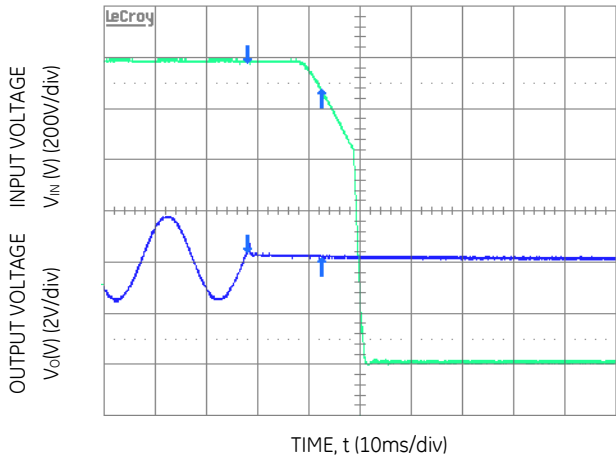

Figure 7. Typical Hold-up waveforms ($V_{IN} = 115V$, 100% load).

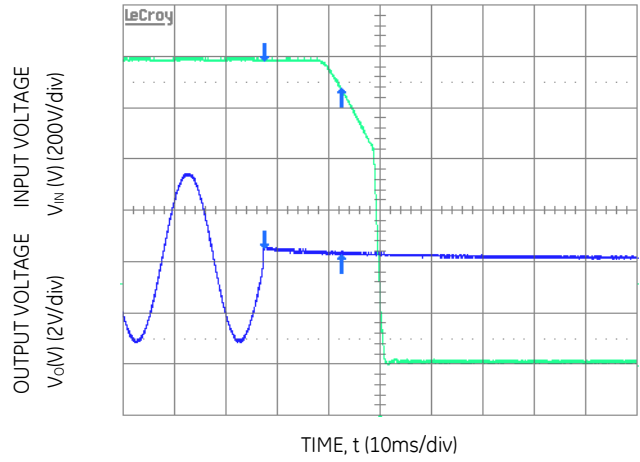

Figure 8. Typical Hold-up waveforms ($V_{IN} = 230V$, 100% load).

CLP0212 Open Frame Power Supply

90 - 264Vac input; 12Vdc output; 200W Output Power

Safety Considerations

The CLP0212 power supply is intended for inclusion in other equipment and the installer must ensure that it is in compliance with all the requirements of the end application. This product is only for inclusion by professional installers within other equipment and must not be operated as a stand-alone product. The power supply meets Class 1, IEC60950, EN60950, with the following deviations: Nemko. UL 60950 (Recognized Component) C-UL (Canadian Approval by UL).

Feature Descriptions

Standby Power Supply

A standby output in the CLP0212 power supply of either 3.3 or 5V, comes on when AC input in the operating range is applied. In the Z02A and Z03A versions of the power supply, the standby output is not accessible.

Remote On/Off

All versions of the CLP0212 power supply except the Z02A and Z03A versions feature a TTL-compatible On/Off control input. The power supply turns ON when the On/Off input goes low, and turns OFF when the input goes high. Note that if the On/Off pin is left unconnected, the power supply main output remains off.

Figure 9 shows the circuit configuration for using the On/Off pin. Either a suitable semiconductor device such as a BJT or FET or a mechanical switch can be used to turn the power supply On and Off. The switch must be capable of handling the On/Off pin current which may be up to 6mA when closed. The switch On voltage drop must also be sufficiently small so that the photo diode inside the power supply is turned ON when the external switch is ON.

Note that the standby output voltage could be either 3.3V or 5V depending on the CLP0212 power supply variant selected. If no On/Off control is desired, the On/Off pin can be externally connected to the COM pin and the power supply will automatically turn ON when AC input is within range.

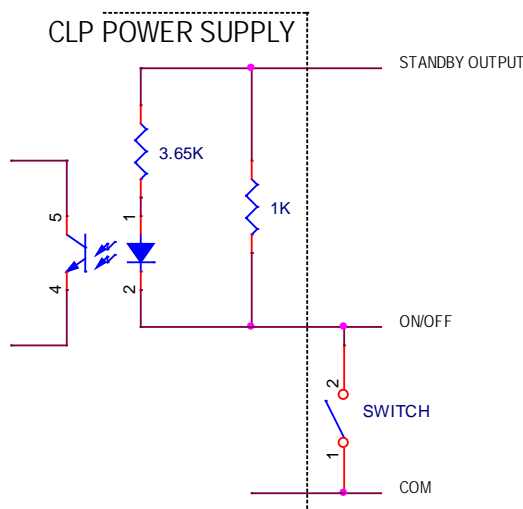

Fig. 9. Schematic showing ON/OFF circuitry.

Output Voltage Adjustment

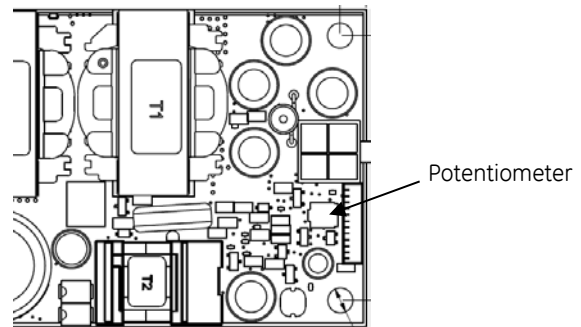

Fig. 10. Diagram showing location of the potentiometer used to adjust the power supply output voltage.

The output voltage can be adjusted between 11.4V and 12.6V using a potentiometer on the power supply. See Fig. 10 for a diagram showing location of the potentiometer.

Remote Sense

The power supply has both positive and negative remote sense connections that can be connected to the positive and negative rails of the main output near the load. Care should be taken in routing the sense lines to ensure that noise is not picked up or that additional filtering elements that affect the stability of the power supply are not used. The power supply will operate without the remote sense connections being made, however if remote sense near the load is not used it is recommended that the remote sense lines be connected directly to the main output terminals.

Overcurrent Protection

To provide protection in a fault condition (output overload), the power supply is equipped with internal current-limiting circuitry and can endure current limiting continuously. At the point of current-limit inception, the unit enters hiccup mode. The power supply operates normally once the output current is brought back into its specified range.

Overvoltage Protection

Overvoltage protection is a feature of the CLP0212 power supply that protects both the load and the power supply from an output overvoltage condition. When an overvoltage occurs, the power supply shuts down and goes into hiccup mode until the overvoltage condition is removed. It is not necessary to recycle the input to restart the power supply when this protection is activated.

Overtemperature Protection

The CLP0212 also features overtemperature protection in order to provide additional protection in a fault condition. The power supply is equipped with a thermal shutdown circuit which detects excessive internal temperatures and shuts the unit down. Once the power supply goes into overtemperature shutdown, it will cool before attempting to restart. The overtemperature protection circuit will typically activate when the unit is operated at 200W output with an ambient temperature of 60°C and 1m/s (200LFM) airflow.

CLP0212 Open Frame Power Supply

90 - 264Vac input; 12Vdc output; 200W Output Power

Input Undervoltage Lockout

At input voltages below the input undervoltage lockout limit, power supply operation is disabled. The power supply will begin to operate at an input voltage above the undervoltage lockout turn-on threshold. Note that the undervoltage lockout limits are load dependent and the power supply turns ON and can operate at much lower input voltage levels when at light or no load.

DC OK

The CLP0212 provides a DC OK signal that indicates when the output has come up and is in regulation. This is an open-collector type signal that goes high when the output is available and within regulation.

Power Good LED

A green LED (located next to HDR3) illuminates when the main output voltage is above 10V.

Paralleling/Load Share

This power supply can be paralleled to provide larger load currents than can be delivered from a single power supply. Up to four power supplies may be paralleled. Paralleling is accomplished by connecting the Current Share signals of multiple power supplies together. At load current levels above 20%, the output currents of multiple power supplies will be within $\pm 5\%$ of the full load value.

If remote sense is used when paralleling is employed, the remote sense connection points should be common to both power supplies.

For applications where redundancy among paralleled power supplies is desired, ORing diodes or other active ORing circuitry needs to be connected in series with each output.

Thermal Considerations

The power supply can be operated in a variety of thermal environments; however sufficient cooling should be provided to ensure reliable operation.

Considerations include ambient temperature, airflow, power supply dissipation and the need for increased reliability. A reduction in the operating temperature of the power supply will result in increased reliability. The thermal data presented here is based on measurements taken in a wind tunnel.

Heat Transfer via Convection

Increased airflow through the power supply enhances the heat transfer via convection. Figure 11 shows the preferred airflow direction. Contact your GE Energy technical representative for derating information in other airflow directions.

Note: Under Natural Convection cooling conditions, the maximum load is restricted to 100W as OTP will be triggered at higher loads.

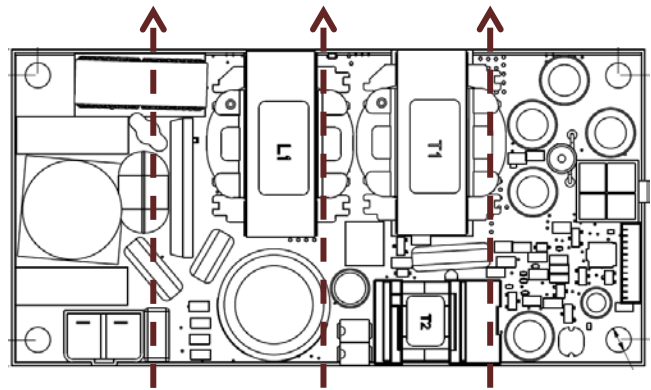

Fig. 11. Preferred airflow direction for cooling.

Operation In a Sealed Enclosure

The CLP0212 power supply can also be operated in a sealed enclosure provided proper means for removing heat from the power supply are used. Figure 12 shows an arrangement where a thermally conductive pad is used to transfer heat from the bottom of the power supply into the enclosure. Under such conditions, the power supply is capable of reduced power operation as shown in Table 1. Note that the Ambient Temperature shown in Table 1 is that outside the sealed enclosure, the CLP0212 may see higher ambient temperatures.

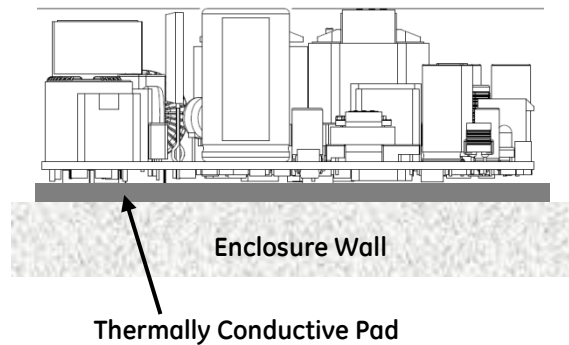

Fig. 12. Example arrangement of the CLP0212 for sealed enclosure applications.

Table 1. Output Power Capability when the CLP0212 is operated in a sealed enclosure with thermal pad for conduction cooling.

Ambient Temperature (°C)	Max. Output Power (W)
25	170
40	150
55	110

CLP0212 Open Frame Power Supply

90 - 264Vac input; 12Vdc output; 200W Output Power

EMI performance

All CLP0212 power supplies are specified to meet conducted Class A EMI requirements per CISPR 22 (EN55022) with at least 3dB of margin. Results of tests conducted without any external filtering are shown below. These indicate 10dB or better of margin over the Class A limits.

CLP0212FPXX5Z01A (120VAC in, 12V @ 180W out, Negative of Output Grounded)

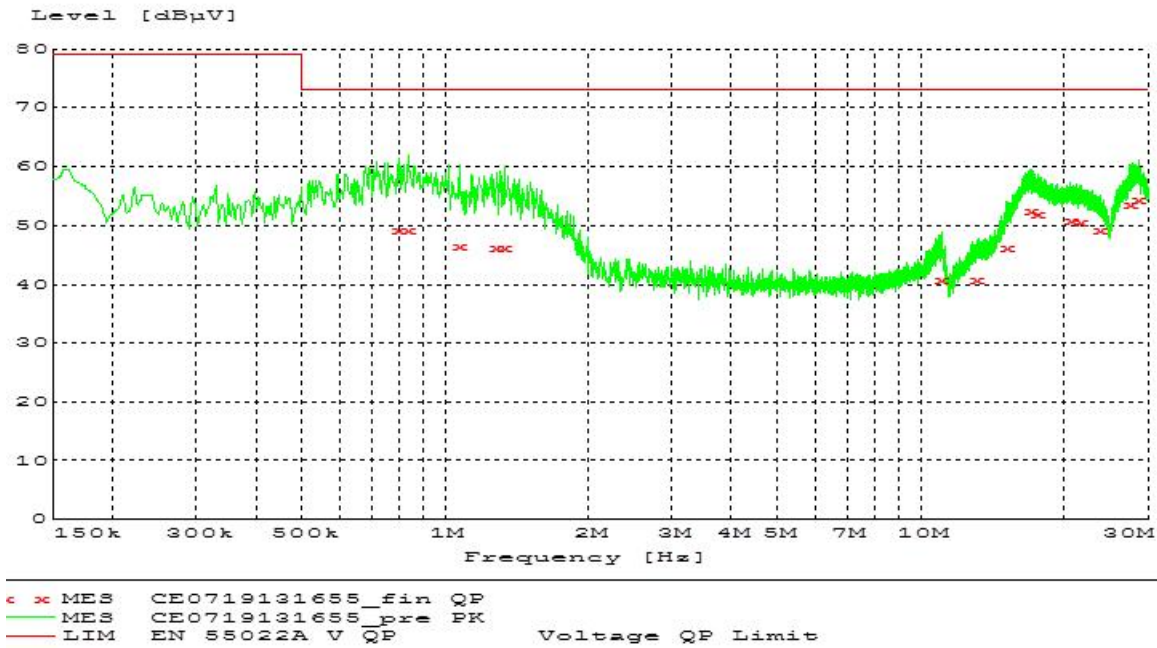

CLP0212FPXX5Z01A (208VAC in, 12V @ 180W out, Negative of Output Grounded)

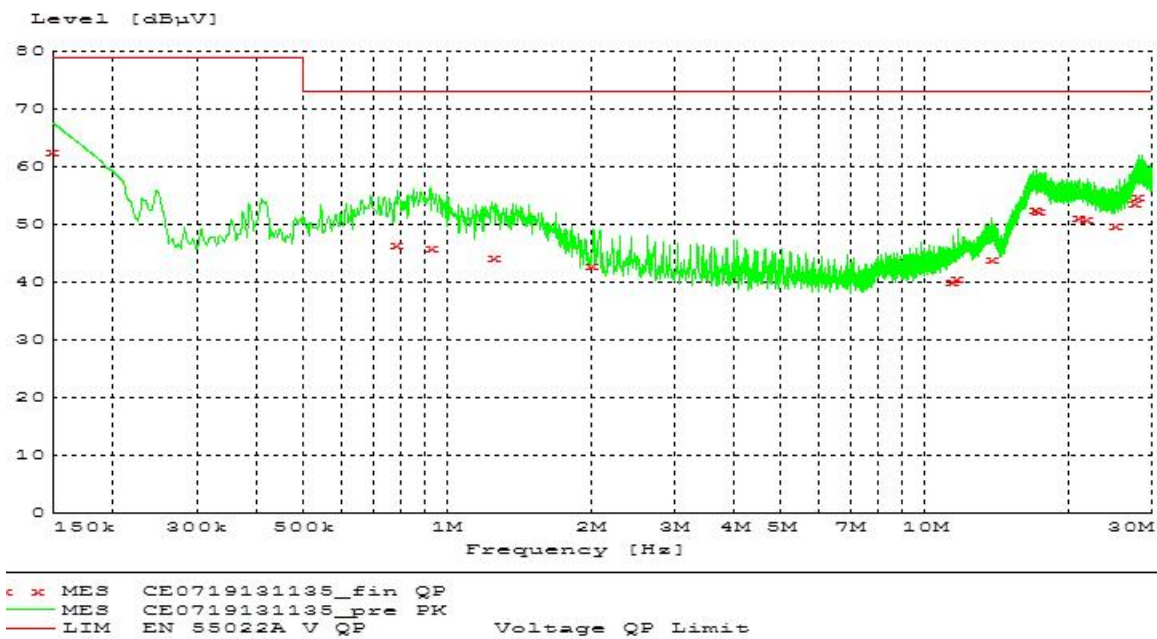

CLP0212 Open Frame Power Supply

90 - 264Vac input; 12Vdc output; 200W Output Power

CLP0212FPEX5Z03A (120VAC in, 12V @ 180W out, Negative of Output Grounded)

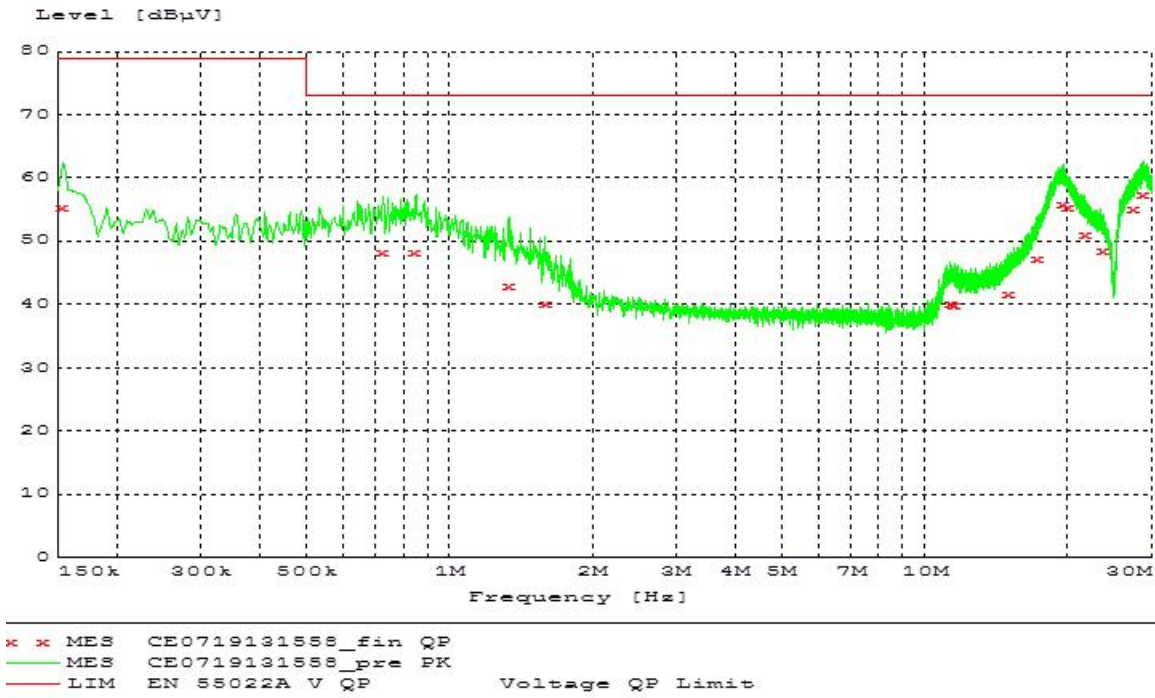

CLP0212FPEX5Z03A (208VAC in, 12V @ 180W out, Negative of Output Grounded)

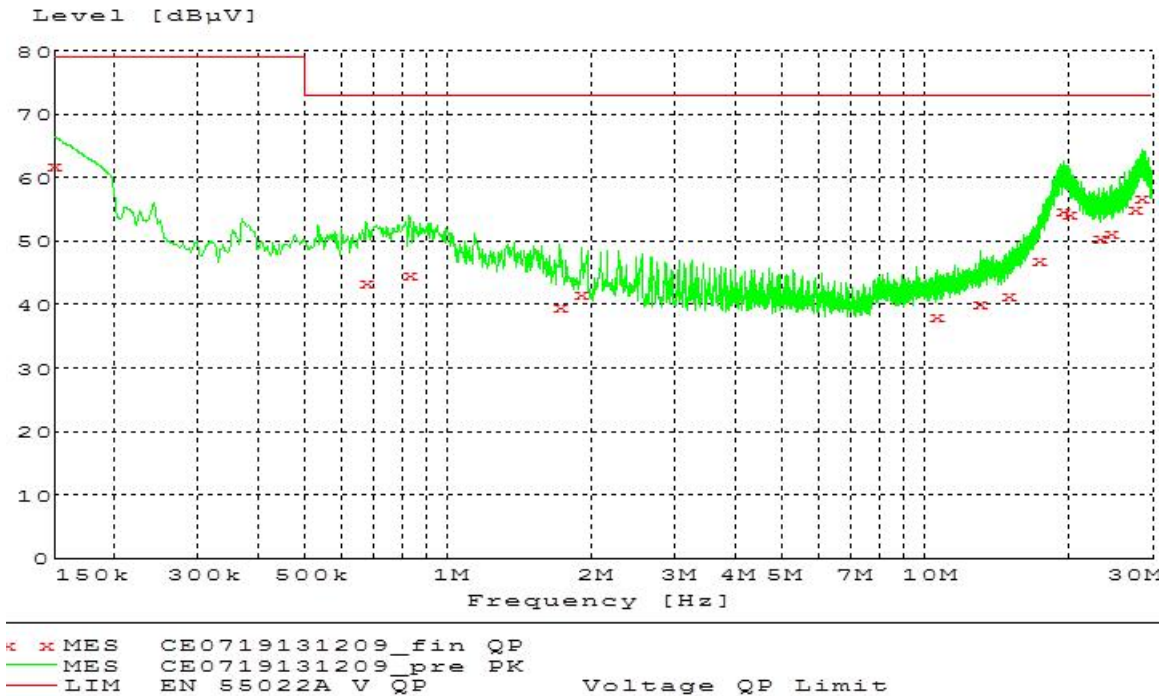

CLP0212 Open Frame Power Supply

90 - 264Vac input; 12Vdc output; 200W Output Power

CLP0212FPEX5Z03A + 2 x 4.7nF "Y" capacitors + 0.47µF "X" capacitors (120VAC in, 12V @ 180W out, Negative of Output Grounded)

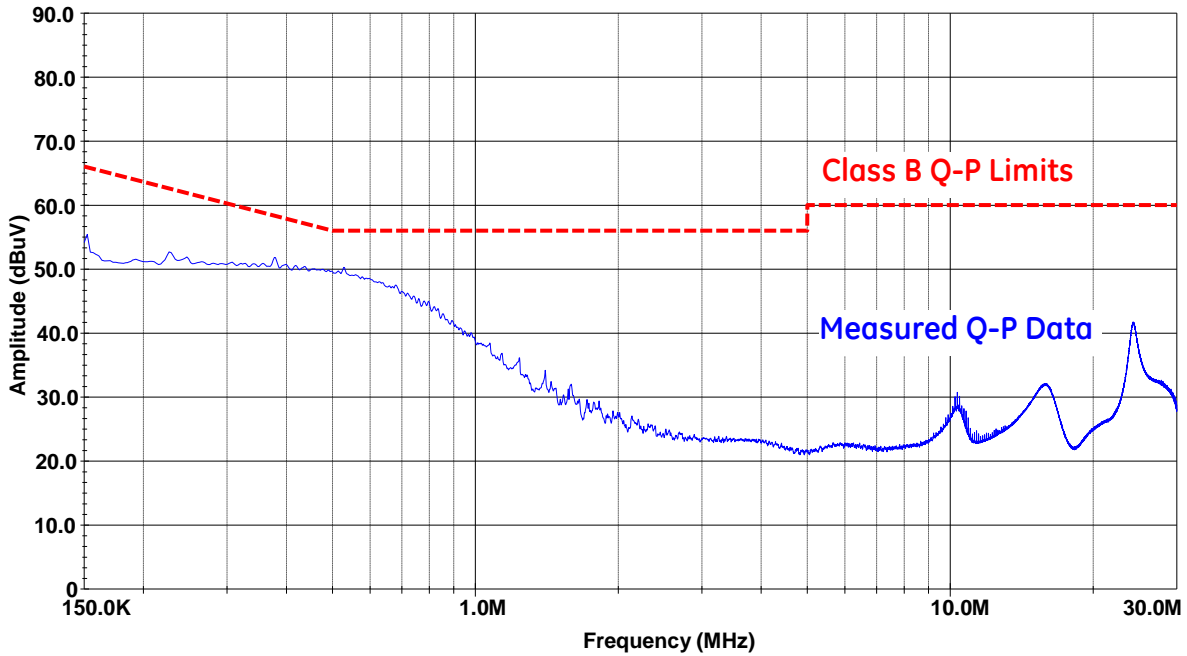

CLP0212FPEX5Z03A + 2 x 4.7nF "Y" capacitors + 0.47µF "X" capacitors (208VAC in, 12V @ 180W out, Negative of Output Grounded)

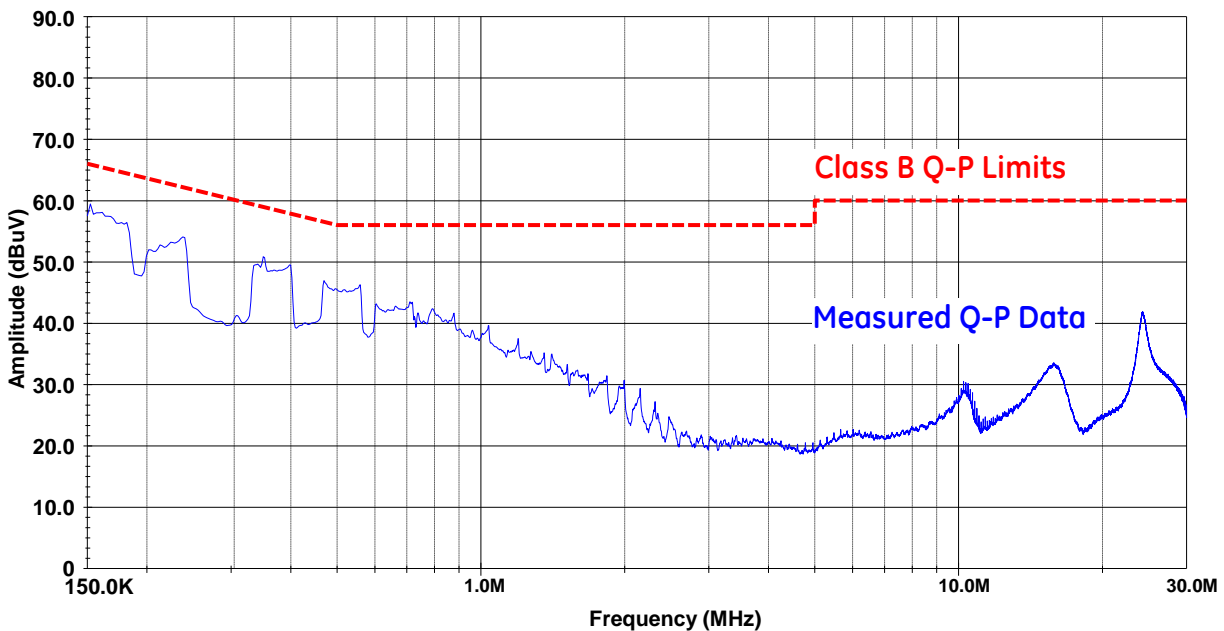

CLP0212 Open Frame Power Supply

90 - 264Vac input; 12Vdc output; 200W Output Power

Mechanical Outline (all except CLP0212...Z02A & CLP0212...Z03A, C versions)

Dimensions are in millimeters.
 Tolerances: x.x mm ± 0.5mm [unless otherwise indicated]
 x.xx mm ± 0.25mm

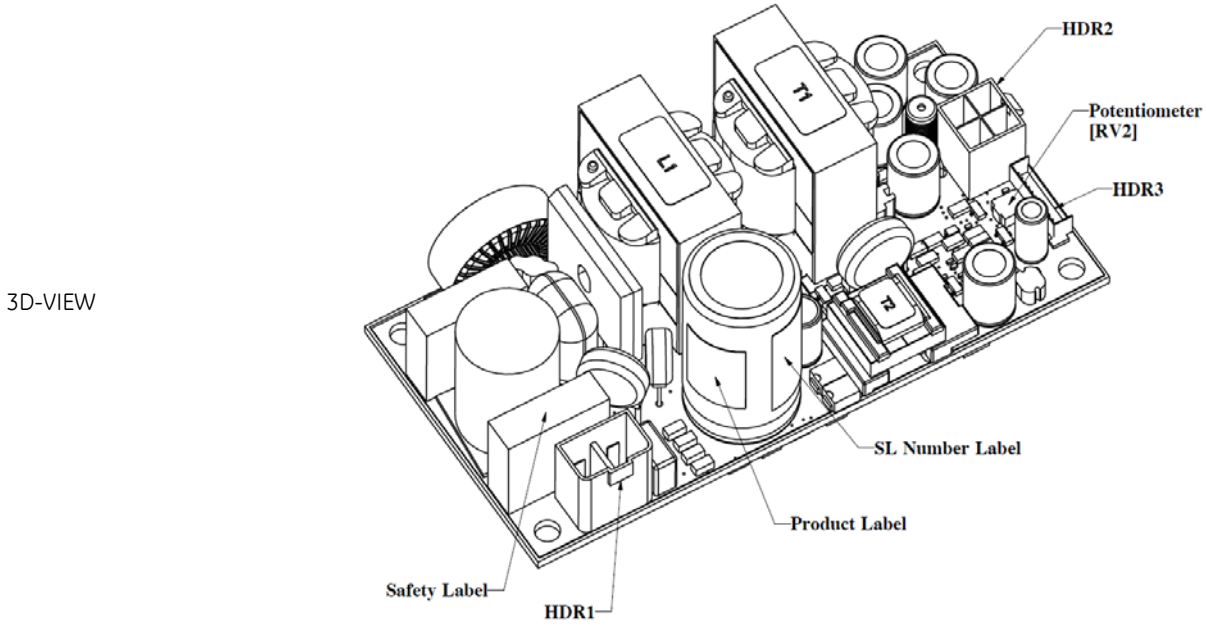
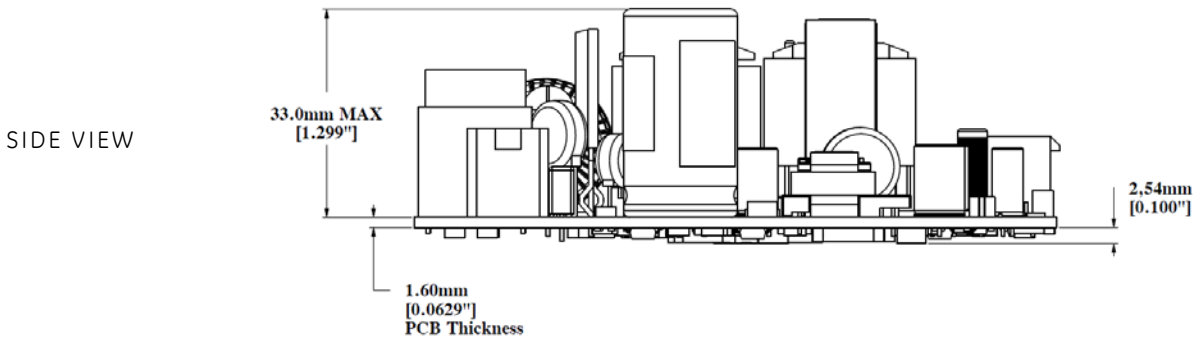
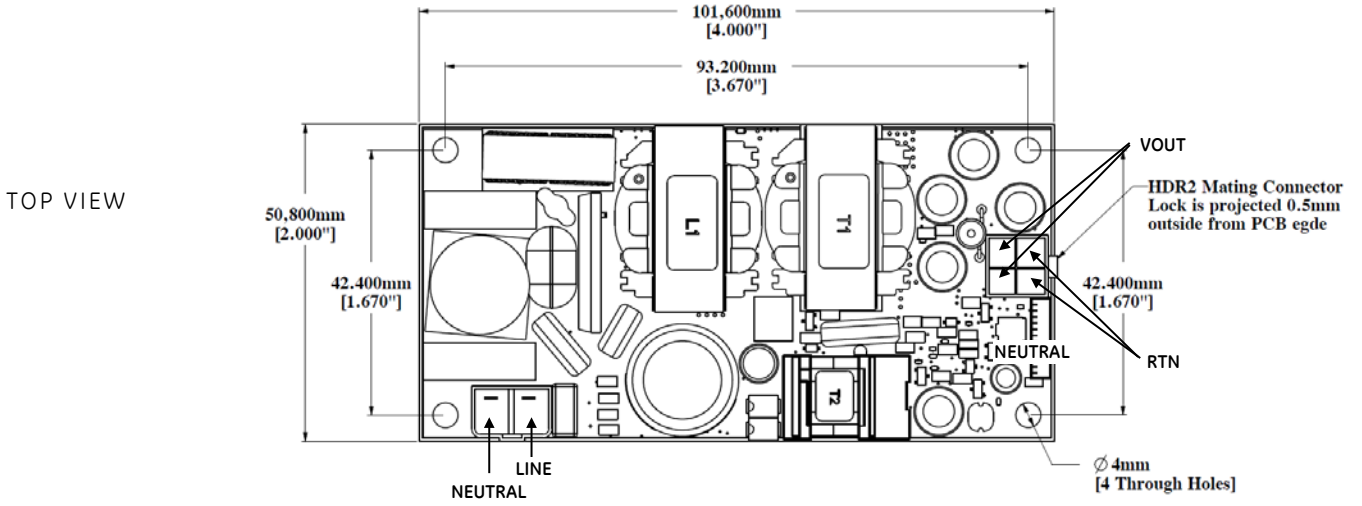

CLP0212 Open Frame Power Supply

90 - 264Vac input; 12Vdc output; 200W Output Power

Mechanical Outline - CLP0212FPEX5Z02A

Dimensions are in millimeters.
 Tolerances: x.x mm ± 0.5mm [unless otherwise indicated]
 x.xx mm ± 0.25mm

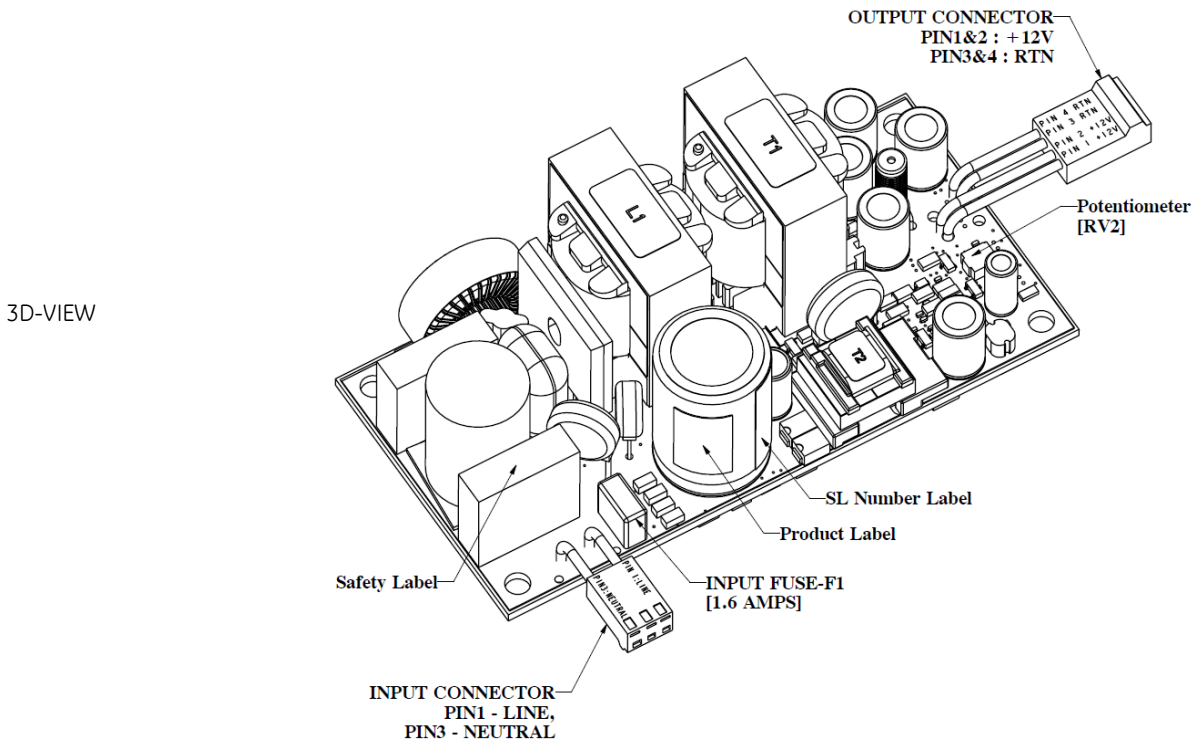
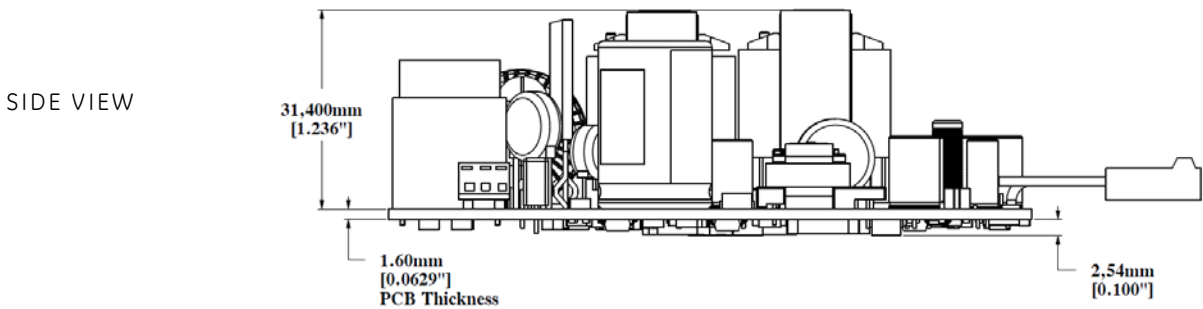
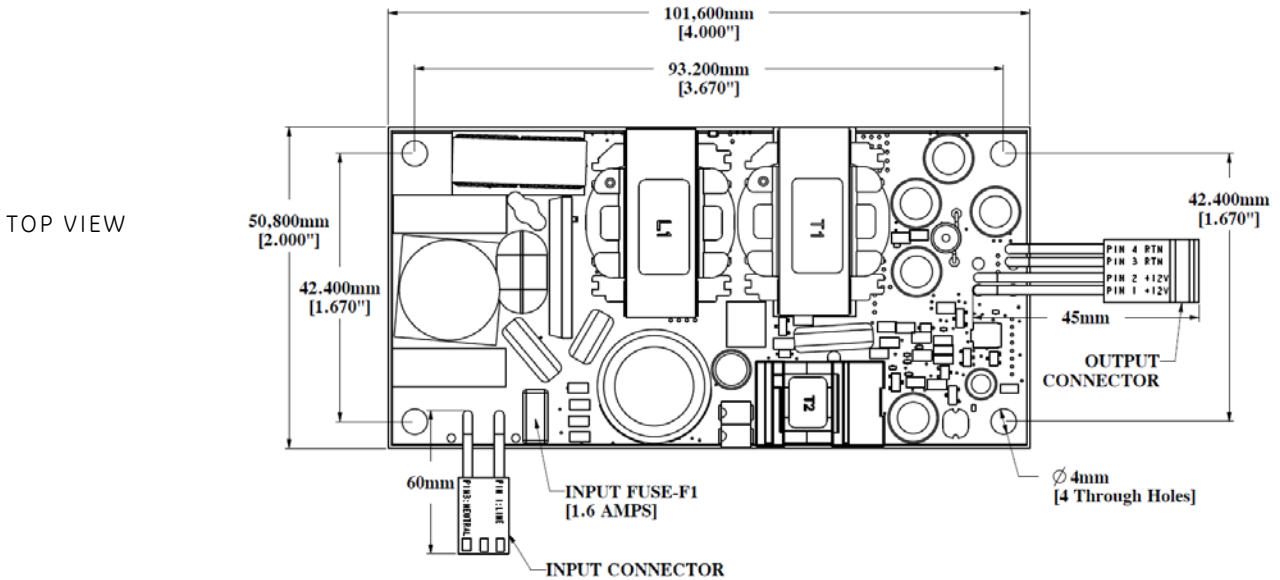

CLP0212 Open Frame Power Supply

90 - 264Vac input; 12Vdc output; 200W Output Power

Mechanical Outline - CLP0212FPEX5Z03A, C

Dimensions are in millimeters.
 Tolerances: x.x mm ± 0.5mm [unless otherwise indicated]
 x.xx mm ± 0.25mm

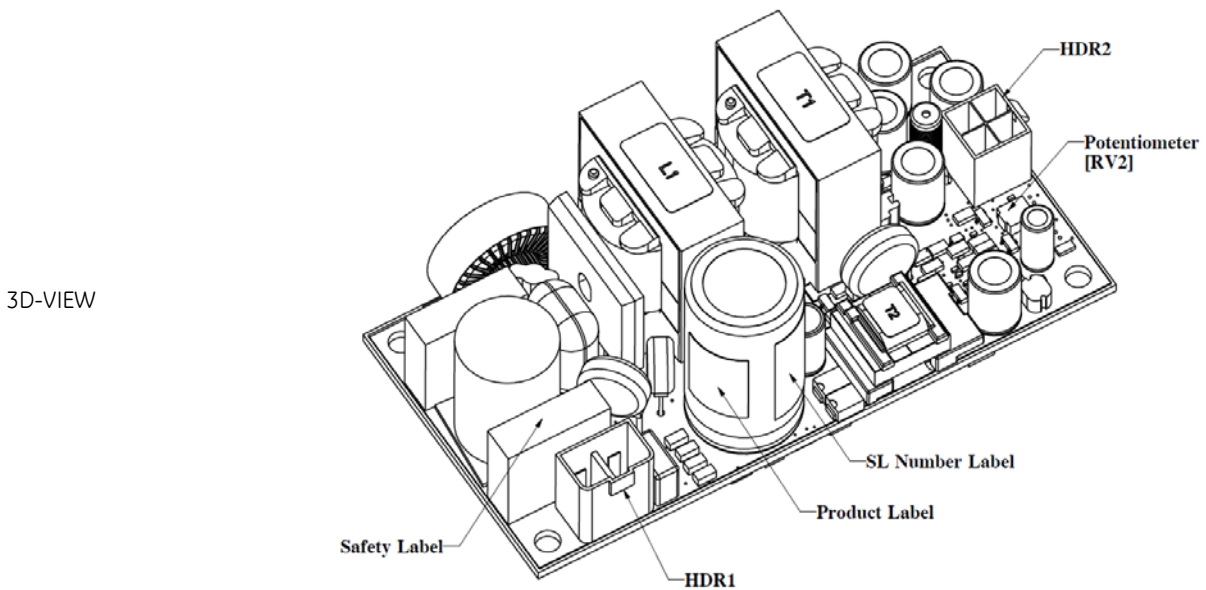
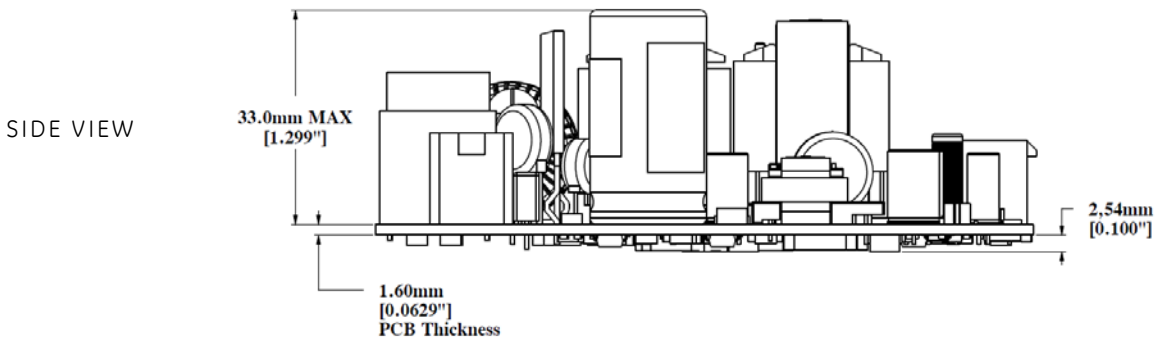
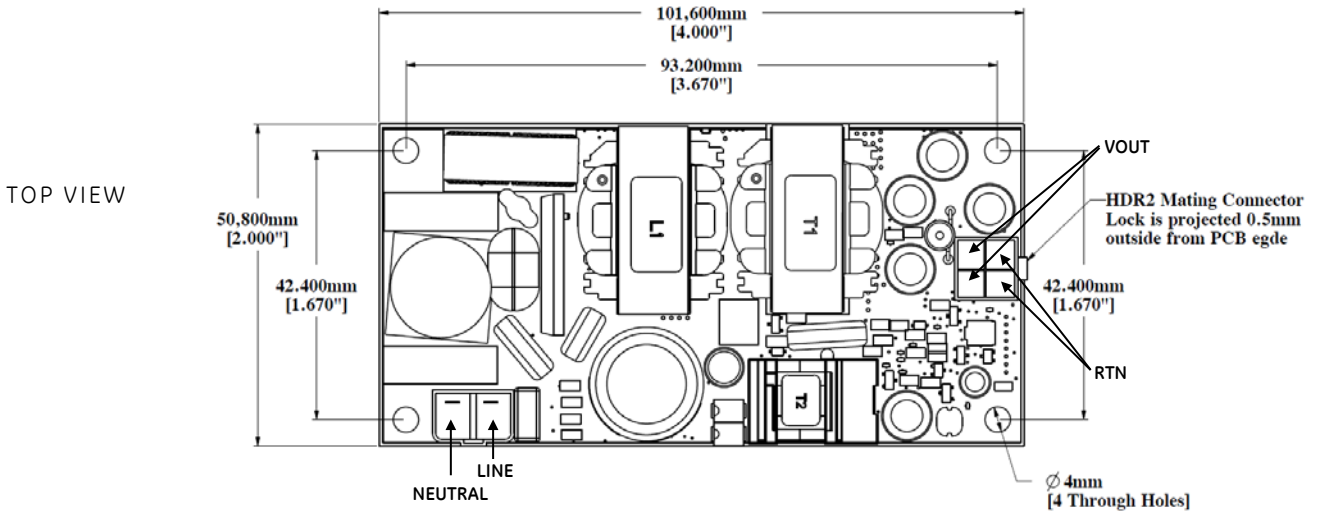

CLP0212 Open Frame Power Supply
 90 - 264Vac input; 12Vdc output; 200W Output Power

Connector Information

Connector	Connector on Power Supply	Mating Connector
AC Input Connector (HDR1)	5-1376382-1 from Tyco or equivalent	1376388-1 from Tyco or equivalent
DC Output Connector (HDR2)	39-28-1043 from Molex or equivalent	39-01-2040 from Molex or equivalent
Signal Connector (HDR3)	53047-0810 from Molex or equivalent	51021-0800 from Molex or equivalent

Pinout Information

AC Input Connector (HDR1)		DC Output Connector (HDR2)		Signal Connector (HDR3)	
Pin 1	Line	Pin 1	VO	Pin 1	Current Sense
Pin 2	Neutral	Pin 2	VO	Pin 2	+S (Remote Sense +)
		Pin 3	RTN	Pin 3	-S (Remote Sense -)
		Pin 4	RTN	Pin 4	Remote On/Off
				Pin 5	DC-OK (Output OK)
				Pin 6	COM (Output Return)
				Pin 7	COM (Output Return)
				Pin 8	Standby Output

Note: Signal Connector HD3 is not present in the Z02A and Z03A, C versions.

CLP0212 Open Frame Power Supply

90 - 264Vac input; 12Vdc output; 200W Output Power

Ordering Information

Please contact your GE Sales Representative for pricing, availability and optional features.

Table 2. Device Codes

Device Code	Input Voltage Range	Output Voltage	Output Current	On/Off Control	Standby Supply	Temperature Range	Comcode
CLP0212FPXX5Z01A*	90 - 264Vac	12.0Vdc	16.7A	Negative Logic	5V@0.25A	-25 to 70°C	150032000
CLP0212FPXX3Z01A*	90 - 264Vac	12.0Vdc	16.7A	Negative Logic	3.3V@0.25A	-25 to 70°C	150032001
CLP0212FPEX5Z01A*	90 - 264Vac	12.0Vdc	16.7A	Negative Logic	5V@0.25A	-40 to 70°C	150032002
CLP0212FPEX5Z02A*	90 - 264Vac	12.0Vdc	8.34A	Absent	Not accessible	-40 to 70°C	150032003
CLP0212FPEX5Z03A*	90 - 264Vac	12.0Vdc	16.7A	Absent	Not accessible	-40 to 70°C	150032004
CLP0212FPXX5Z03A*	90 - 264Vac	12.0Vdc	16.7A	Absent	Not accessible	-25 to 70°C	150032005
CLP0212FPEX5Z01C	90 - 264Vac	12.0Vdc	16.7A	Negative Logic	5V@0.25A	-40 to 70°C	150038518
CLP0212FPEX5Z03C	90 - 264Vac	12.0Vdc	16.7A	Absent	Not accessible	-40 to 70°C	150038520

* Not recommended for new designs

Contact Us

For more information, call us at

USA/Canada:

+1 877 546 3243, or +1 972 244 9288

Asia-Pacific:

+86.021.54279977*808

Europe, Middle-East and Africa:

+49.89.878067-280

www.gecriticalpower.com



GE Critical Power reserves the right to make changes to the product(s) or information contained herein without notice, and no liability is assumed as a result of their use or application. No rights under any patent accompany the sale of any such product(s) or information.